

Varenummer: 201220477

Beskrivelse: E+G Magnet m/gevindbøsning GN 50.2-HF-80-M1
Hård ferrit - 200° C, 600N

Mål

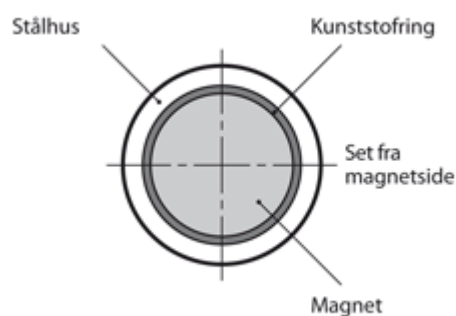

d1 = 80 +0,5/-0,1

d2 = M10x16

d3 = 20 ±0,1

h = 18 +0,5/-0,1

Holdekraft N = 600

Materiale = HF Hård ferrit - 200° C

t = 15